

Chapter 3

LABEL HOLDERS



Acrylic menu
page 50



Label holder for hooks
page 54



Suction cups
page 56



Chalk markers
page 57

This chapter gathers a collection of small devices that can help you to attach labels or small prints in various places within a shop environment, in order to communicate prices or other information.

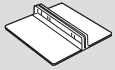

Chapter 3 - LABEL HOLDERS

SALES MANAGER 2011-2012

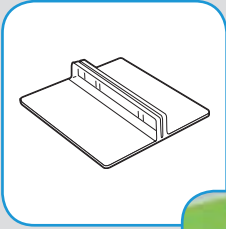

Label support 40x50 mm, with vertical display for prints. Maximum print thickness: 200-400 g/sqm. Available color: clear.

FPP 001-03 10.56 EUR / 100PCS



Label support of different sizes, with inclined display for prints at 75°. Maximum print thickness: 200-400 g/sqm. Available color: clear.

FPP 022-03 with base of 40x60 mm 10.56 EUR / 100PCS
FPP 023-03 with base of 33x45 mm 32.78 EUR / 100PCS
FPP 024-03 with base of 20x35 mm 26.29 EUR / 100PCS



Display made of plastic foot 75 x 40 mm, with a clear 25 mm label holder for max 0,5 mm labels.

FAP 136-00 42.48 EUR / 100PCS



Clear clamp with a clear 25 mm holder. The clamp can take max 8 mm and the holder can get max 0,5 mm labels.

FAP 123-00 49.39 EUR / 100PCS

Menu stand with 75° inclination, made of clear material, different thicknesses depending on the label dimension.

CPA 097-00/L	A7 landscape, 0,5 mm thickness	0.8 EUR / PC
CPA 097-00/P	A7 portrait, 0,5 mm thickness	0.8 EUR / PC
CPA 098-00/L	A6 landscape, 1 mm thickness	1.83 EUR / PC
CPA 098-00/P	A6 portrait, 1 mm thickness	1.83 EUR / PC
CPA 099-00/L	A5 landscape, 1,5 mm thickness	2.67 EUR / PC
CPA 099-00/P	A5 portrait, 1,5 mm thickness	2.67 EUR / PC
CPA 100-00/L	A4 landscape, 2 mm thickness	5.42 EUR / PC
CPA 100-00/P	A4 portrait, 2 mm thickness	5.42 EUR / PC
CPA 101-00/P	A3 portrait, 2 mm thickness	9.24 EUR / PC

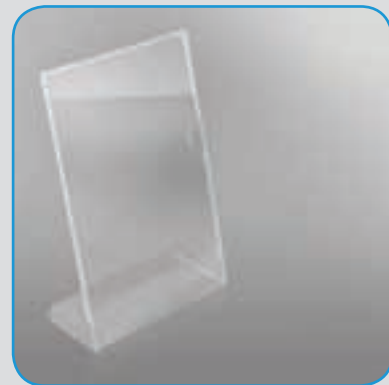

Menu stand 90 x 40 mm landscape, 0,3 mm thickness material, non reflective. On request we can deliver other dimensions made of different materials.

CPA 218-00 0.29 EUR / PC



Snap, anodized aluminium extrusion to take acrylic U pockets of 2 mm thickness (a total of 2+2 mm). The final appearance is a very elegant one due to the nice finish of the aluminium. There is the possibility to place an adhesive label on it.

CPA 287-991	74 mm length	4.9 EUR / PC
CPA 286-991	105 mm length	5.5 EUR / PC
CPA 285-991	148 mm length	8.2 EUR / PC
CPA 284-991	210 mm length	9.1 EUR / PC



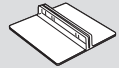

Plastic base for U pocket with maximum thickness 0,8 - 2 mm.
The base can be personalized.

- CPA 283-421** Menu support 1/3A4 (102x210 mm), print thickness 1,8 mm
1.08 EUR / PC
- CPA 282-421/1** Menu support A5 (150x210 mm), print thickness 1,8 mm
1.25 EUR / PC
- CPA 282-421/2** Menu support A5 (150x210 mm), print thickness 4,2 mm
1.25 EUR / PC
- CPA 281-421** Menu support A4 (210x297 mm), print thickness 4,2 mm
2.09 EUR / PC

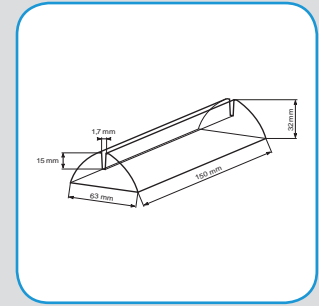
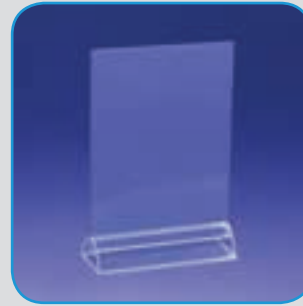

U pockets of 0,8 mm thickness. By request the pockets can have different sizes.

- RAP 399-00/08P** 1/3A4 portrait 1.41 EUR / PC
- RAP 395-00/08P** A5 portrait 1.65 EUR / PC

U pockets made of 1 mm plexiglass (1+1 mm as total). By request the pockets can have different sizes.

- RAP 399-00/1P** 1/3A4 portrait 1.48 EUR / PC
- RAP 395-00/2P** A5 portrait 2.51 EUR / PC
- RAP 394-00/1P** A4 portrait 2.8 EUR / PC

U pockets made of 2 mm plexiglass (2+2 mm as total) for Snap alu bases, or others. By request the pockets can have different sizes.

- RAP 397-00/2P** A7 portrait 1.35 EUR / PC
- RAP 396-00/2P** A6 portrait 1.72 EUR / PC
- RAP 395-00/2P** A5 portrait 2.51 EUR / PC
- RAP 394-00/2P** A4 portrait 3.96 EUR / PC



Clear stand with round base, 75 mm stand,
A5P U plexiglass 2 mm pocket.
RPX 128-01 8.03 EUR / PC

Clear stand with round base, 75 mm stand,
A4P U plexiglass 2 mm pocket.
RPX 129-01 9.35 EUR / PC



ONDA stand with plexiglass pocket, perforated support,
320 mm rod, conical DEKO base. Colors for support:
grey, red, ultramarin, silver. Colors for base: yellow-blue,
black- yellow, ultramarin- ultramarin, ultramarin- yellow,
black- chrom, silver-silver.

- RPX 127-01/A5** with U plexiglass 2 mm, A5 landscape pocket 13.53 EUR / PC
- RPX 127-01/A4** with U plexiglass 2 mm, A4 portrait pocket 14.52 EUR / PC

U pocket, made of 2 mm plexi.

- RAP 394-00/2L** A4 landscape 4.07 EUR / PC
- RAP 393-00/2L** A3 landscape 6.98 EUR / PC



U-frame stand, chromium tube 310 mm Ø
10+12 mm, plastic base RAX 015. Plexiglass 2
mm pocket not included.

A4 landscape. Colors: white, grey, red, yellow

RPX 164-01 6.82 EUR / PC

A3 landscape. Colors: silver, black, yellow.

RPX 164-01/A3 10.67 EUR / PC

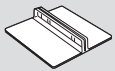

Chapter 3 - LABEL HOLDERS

Soft pockets, made of clear glossy 0,15 mm PVC, welded on the edges and with „euro-hole“ or simple perforation. Mainly used in furniture showrooms for price labelling.

label dimension A5

RAP 367-149 0.73 EUR / PC

label dimension A6

RAP 368-149 0.36 EUR / PC

label dimension A7

RAP 369-149 0.25 EUR / PC

two labels: 115 x 160 mm, 115 x 55 mm

RAP 319-149 0.42 EUR / PC

three labels: 115 x 160 mm and two of 115 x 55 mm

RAP 320-149 0.47 EUR / PC

two labels: 215 x 78 mm, 65 x 78 mm

RAP 353-149 0.38 EUR / PC



SALES MANAGER 2011-2012



Polypropylene closing loops, non reusable.

With end closure, 125 mm

FAP 201-31 8.55 EUR / 1000PCS

With end closure, 225 mm

FAP 202-31 9.05 EUR / 1000PCS

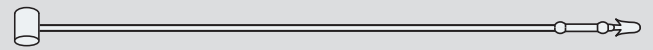

Nylon closing loops with multiple knots, variable closure, non reusable.

length 125 mm

FAP 203-31 12.92 EUR / 1000PCS

length 200 mm

FAP 204-31 47.85 EUR / 1000PCS



Adhesive base Ø 20 mm with a small ring for attaching labels to various surfaces, by using closing loops. Colors: white.

LPP 036-03

8.8 EUR / 100PCS

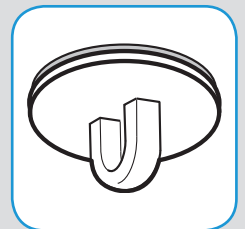

Rigid clear PVC pockets, 0,3 mm thickness non reflective, „C“ shaped with adhesive or magnetic fastening, portrait. Best to be used on white products, such as refrigerators, washing machines, etc. Landscape format is also available.

LPP 158-00/PA format A7, adhesive 0.22 EUR / PC

LPP 158-00/PM format A7, magnetic 0.29 EUR / PC

LPP 157-00/PA format A6, adhesive 0.27 EUR / PC

LPP 157-00/PM format A6, magnetic 0.36 EUR / PC

LPP 153-00/PA format A5, adhesive 0.31 EUR / PC

LPP 153-00/PM format A5, magnetic 0.49 EUR / PC

LPP 154-00/PA format A4, adhesive 0.47 EUR / PC

LPP 154-00/PM format A4, magnetic 0.71 EUR / PC

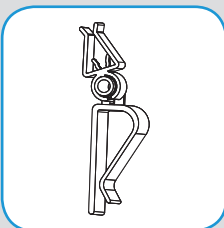

Hinged clamp for fastening onto 20 mm maximum thickness base, for 3,5-4,5 mm prints. It can be used for attaching plexiglass pockets onto beverage crates. For bigger prints we recommend usage of more clamps at the same time.

FPP 288-01

0.84 EUR / PC



Hinged clamp for fastening onto 20 mm maximum thickness base, for 3 mm prints. It can be used for attaching cardboard prints onto beverage crates. For bigger prints we recommend usage of more clamps at the same time.

FPP 280-01

1.32 EUR / PC



Giant clamp for fastening onto 30 mm maximum thickness base. At the other end, it has an 100 mm label holder, for maximum 5 mm thickness prints. Colors: clear.

FPP 281-01 With no intermediate arm 6.27 EUR / PC

FPP 281-01/100 With 100 mm intermediate arm 7.04 EUR / PC

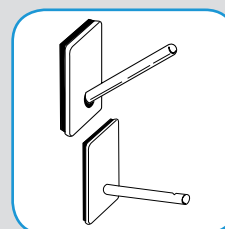

Adhesive adapter to be inserted on 7 mm diameter rods. Used mostly in small stands and miniflags construction. Adhesive foot dimensions: 30 x 20 mm. Colors: white.

LAP 014-44/7 60° inclination

0.36 EUR / PC

LAP 007-44/7 straight, 90°

0.36 EUR / PC

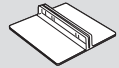

Label holder 30 mm, vertical displaying of 0,5 mm tickets, to be placed on top of the 7 mm diameter tubes. Colors: white, green, black.

FAP 170-44 0.15 EUR / PC

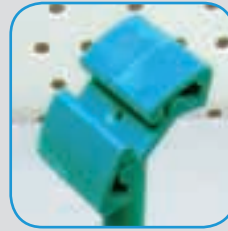

Label holder 30 mm, 60° tilted displaying of 0,5 mm tickets, to be placed on top of the Ø 7 mm tubes. Colors: white, green, black.

FAP 171-44 0.15 EUR / PC

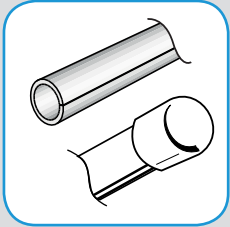

Tube with 7 mm external diameter, 1000 mm length, mostly used for small stands and miniflags construction. Colors: white, black.

LAP 050-44 no longitudinal cutting 0.7 EUR / PC

LAP 050A-44 with longitudinal cutting 0.7 EUR / PC

LAP 012-44 end cap for tubes with 7 mm diameter. Available colors black or white. 8.4 EUR / 100PCS



Plastic foot 90 mm diameter to take 7 mm diameter tubes for mini display stand construction. Colors: white, green, black, grey, red.

FAP 173-44 no metallic core 0.84 EUR / PC

FAP 174-44 with metallic core for a better stability 2.16 EUR / PC



Plastic spike to be inserted in the Ø 7 mm tube, to create price displays. Used very often in gardening products, fixed into the soil. Colors: black.

FAP 172-44 0.15 EUR / PC



Double label holder with clamp, tilted display. Suitable for fixing onto wire structures. Size: 60x45 mm. Colors: green, red, black, white.

FAP 166-44 0.15 EUR / PC

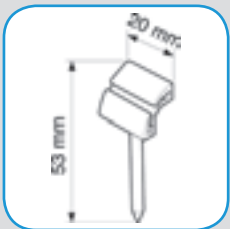

Label holder with 50 mm pin, tilted display. Colors: white.

FPP 066-05 13.2 EUR / 100PCS



Clamp of 140 x 60 mm to be fixed on 10 mm maximum thickness to hold posters of maximum 3 mm thickness. For bigger prints it is better to use more clamps at the same time.

FPP 084-03 1.1 EUR / PC

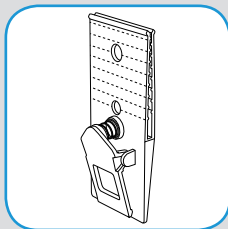

Support for attaching prints on wire structures. Colors: white.

LPP 033-03 50 mm length 27.39 EUR / 100PCS

LPP 034-03 45 mm length 22.99 EUR / 100PCS

LPP 075-03 55 mm length 44.33 EUR / 100PCS

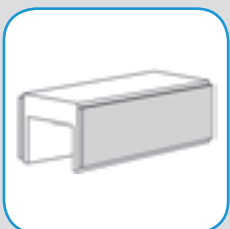

U-section separator 14 mm, length 30mm with adhesive foam. Colors: white.

LPP 019-03 24.2 EUR / 100PCS

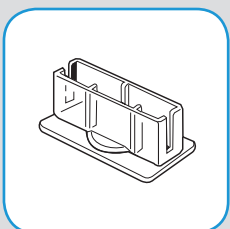

Adhesive base support, 60X27 mm, for vertical prints with thickness of 0,3-2 mm. Colors: clear.

LPP 018-03 33.33 EUR / 100PCS

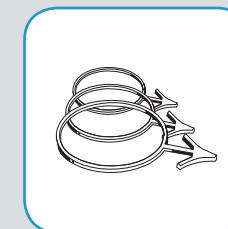

Label loop for bottle necks.

FPP 036-03 Ø 35 mm, transparent opaque 3.52 EUR / 100PCS

FPP 037-03 Ø 40 mm, transparent opaque 3.52 EUR / 100PCS

FPP 038-03 Ø 45 mm, transparent opaque 3.52 EUR / 100PCS

FPP 085-03 minimum Ø 35 mm, black 11.99 EUR / 100PCS

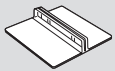

Chapter 3 - LABEL HOLDERS

SALES MANAGER 2011-2012

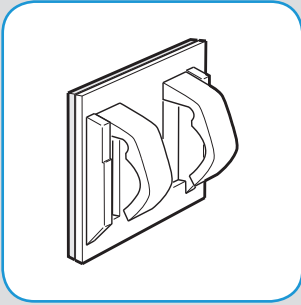

Adhesive support for 3-7 mm diameter wire structures. Colors: white.

LPP 029-03

10.56 EUR / 100PCS



End adaptors for single hooks. Available color: white.

- FPP 090-41** for 3 mm diameter wire
8.7 EUR / 100PCS
- FPP 091-41** for 4 mm diameter wire
8.7 EUR / 100PCS
- FPP 092-41** for 5 mm diameter wire
8.7 EUR / 100PCS
- FPP 093-41** for 6 mm diameter wire
8.7 EUR / 100PCS



Foam adhesive support for print suspension on wire structures. Dimensions: 16x16 mm.

LPP 116-326

10.36 EUR / 100PCS

Snap on pricing tag to take up 25x25 mm self adhesive labels. Standard colors: white, black.

Lock over \varnothing 4 mm wire. Suitable with FPP 091-41. On request, other colors are available.

FPP 310-432 8.1 EUR / 100PCS

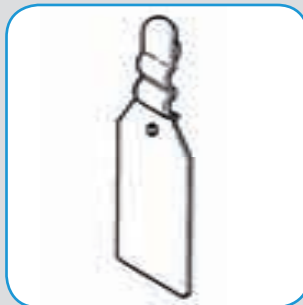

Lock over \varnothing 4,8 mm wire, suitable with FPP 092-41.

FPP 311-432 8.1 EUR / 100PCS

Snap on pricing tag to take up 25x38 mm self adhesive labels. Lock over \varnothing 4,8 mm wire. Suitable with FPP 092-41. Standard colors: white, black. On request, other colors are available.

FPP 312-432 8.1 EUR / 100PCS

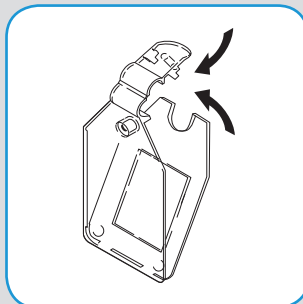

Snap on pricing tag with pocket, for hooks.

Snap on pricing tag with pocket to take up 25x27 mm labels. Suitable with FPP 092-41. Lock over \varnothing 4,8 mm wire. Color: clear.

FPP 313-432 9.72 EUR / 100PCS

Snap on pricing tag with pocket to take up 25x38 mm labels. Suitable with FPP 092-41. Lock over \varnothing 4,8 mm wire. Color: clear.

FPP 314-432 9.72 EUR / 100PCS



Label holder with adaptor for 19 mm diameter hooks. Available color: white.

LAP 044-48

0.2 EUR / PC



Price label holder, special created for „T“ hooks, with an anti-theft system. Recommended for small size products with high value. It can be personalized with a 28x31 mm print. Colour: clear matt.

MAP 021-4211

2.38 EUR / PC

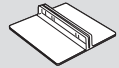

Electrostatic pockets are very easy to apply on glass surfaces. The pockets are made of pvc foil 0,4 mm AR and electrostatic foil on the back side, the side which will be applied on the glass surface. For the pocket to be resistant in time it is necessary that the window / glass surface is perfectly clean.

- | | | | | | |
|-------------------|-------------|---------------|-------------------|---------------------|---------------|
| LPP 134-00 | A4 portrait | 2.09 EUR / PC | LPP 132-00 | A2 portrait | 6.01 EUR / PC |
| LPP 133-00 | A3 portrait | 3.19 EUR / PC | LPP 137-00 | 700X500 mm portrait | 9.75 EUR / PC |



Identification badges and accessories. Minimum q-ties for each product are written below, but you can also buy less q-ty for an extra charge of 30%.

- | | | |
|--------------------|---|-------------------|
| RAP 450-153 | ID badge 60x90 mm with pin clip. Minimum quantity 350 pcs. | 6.17 EUR / 25PCS |
| RAP 451-153 | Retractable cord accessory for ID badges, with maximum length for the cord 60cm. Minimum quantity 1000 pcs. | 13.45 EUR / 10PCS |
| RAP 452-153 | Clips for badges. Minimum quantity 1200 pcs. | 2.68 EUR / 10PCS |



Self-laminating foil, protects your valuable prints from losing their colour, keeping them sealed away from dust, dirt, grease, stains and moisture. No laminating machine required.

- | | | |
|--------------------|--------------------------------------|-------------------|
| RAP 453-153 | 66x100 mm. Minimum quantity 1200 pcs | 2.63 EUR / 10PCS |
| RAP 454-153 | A4, minimum quantity 240 pcs | 13.65 EUR / 10PCS |
| RAP 455-153 | A5, minimum quantity 600 pcs | 9.7 EUR / 10PCS |
| RAP 456-153 | A6, minimum quantity 600 pcs | 27.17 EUR / 50PCS |
| RAP 457-153 | A7, minimum quantity 1200 pcs | 3.54 EUR / 10PCS |



Self-laminating signs for A4 prints, protects your valuable prints from losing their colour, keeping them sealed away from dust, dirt, grease, stains and moisture. No laminating machine required. You can stick them on window, doors, tables or any other surfaces that allows adhesive mounting, due to its back adhesive strips. Minimum quantity: 240 pcs.

- | | |
|--------------------|------------------|
| RAP 462-153 | 15.6 EUR / 10PCS |
|--------------------|------------------|

Metal clip and plastic base support. The base is available as cube or con-shaped. Available colors: black, grey. On request and for an extra-cost they can be imprinted.

Cube base. Dimensions: 36x36x36 mm, height (including clip) 100 mm.

- | | |
|----------------------|---------------|
| LAP 330-072/1 | 1.61 EUR / PC |
|----------------------|---------------|

Con-shaped base. Base diameter 40 mm, height (including clip) 104 mm.

- | | |
|----------------------|---------------|
| LAP 330-072/2 | 1.61 EUR / PC |
|----------------------|---------------|



Adhesive plastic pockets. Designed as a practical storage solution for samples, promotional products, advertising campaign materials and special offers. You can put them on windows, doors, presentation maps, books or any other surfaces that allow adhesive mounting. Available for portrait and landscape form. Color: transparent.

- | | | |
|--------------------|--|-------------------|
| RAP 458-153 | A4, minimum quantity 500 pcs | 50.21 EUR / 50PCS |
| RAP 459-153 | A5, minimum quantity 500 pcs | 39.19 EUR / 50PCS |
| RAP 460-153 | A6, minimum quantity 500 pcs | 23.85 EUR / 50PCS |
| RAP 461-153 | 95x60 mm, for business cards, long side entry. Minimum quantity 1000 pcs | 17.4 EUR / 100PCS |



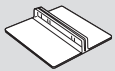

Suction cups: tipped suction cups, knob suction cups, screw suction cups, clamp suction cups, hook suction cups, all kinds

of suction cups. The prices are available for a quantity up to 1000 pcs. Available color: clear.



Flat knob suction cups of 12 mm in diameter.

Suction cup diameter 30 mm
LPP 104-73 26.4 EUR / 100PCS

Suction cup diameter 40 mm
LPP 105-73 29.04 EUR / 100PCS

Suction cup diameter 50 mm
LPP 106-73 29.7 EUR / 100PCS

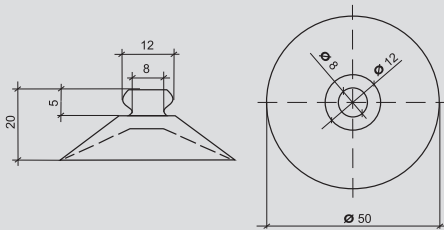

Suction cups with pointed knob.

Suction cup diameter: 20 mm, knob: 7,1 mm
LPP 111-73 9.24 EUR / 100PCS

Suction cup diameter: 30 mm, knob: 8 mm
LPP 112-73 26.4 EUR / 100PCS

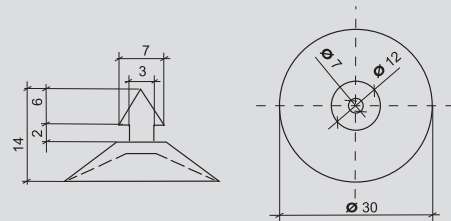

Suction cup with polycarbonate hook.

Suction cup diameter 35 mm
LPP 107-73 54.45 EUR / 100PCS

Suction cup diameter 50 mm
LPP 108-73 59.73 EUR / 100PCS

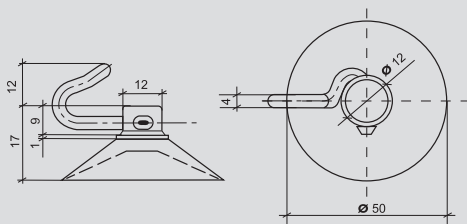

Suction cup with nickelled steel hook.

Suction cup diameter 40 mm
LPP 109-73 42.9 EUR / 100PCS

Suction cup diameter 60 mm
LPP 110-73 68.64 EUR / 100PCS

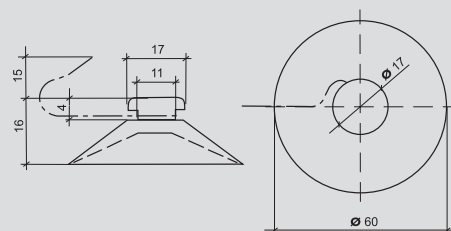

M4 screw suction cup, diameter 50 mm, with extension for easy detachment.

Screw length: 6 mm
LPP 099-73 70.95 EUR / 100PCS

Screw length: 11 mm
LPP 100-73 72.93 EUR / 100PCS

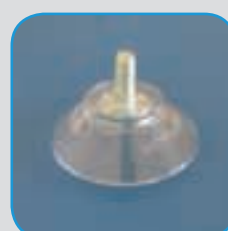
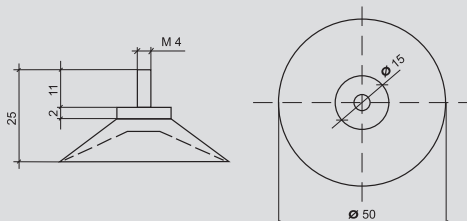

M4, 6mm screw suction cup, perpendicular on the surface.

Suction cup diameter 30 mm
LPP 101-73 54.12 EUR / 100PCS

Suction cup diameter 40 mm
LPP 102-73 63.36 EUR / 100PCS

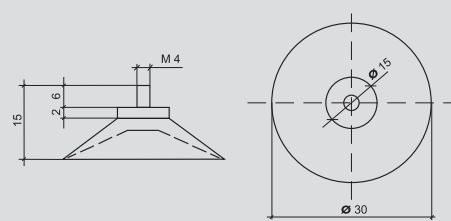

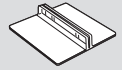

Markers

These chalk powder based markers, which have an extremely opaque aspect after drying on a written surface, are ideal for black boards marking. They offer a vintage, popular, market sensation, and why not, freshness.



Chalk marker, 5 mm point thickness. Available colors: white, red, black.
Illumigraph, washable ink
RAX 001-58 3.24 EUR / PC
Posterman, water resistant ink
RAX 021-58 3.24 EUR / PC



Chalk marker, 15 mm point thickness. Available colors: white, red, black.
Illumigraph, washable ink
RAX 002-58 5.89 EUR / PC
Posterman, water resistant ink
RAX 023-58 5.76 EUR / PC



Chalk marker, 30 mm point thickness. Available colors: white, red.
Illumigraph, washable ink
RAX 019-58 7.05 EUR / PC
Posterman, water resistant ink
RAX 025-58 6.89 EUR / PC



Cleaning solution for water resistant markers. Delivered on one liter bottle.
RAX 022-01 19.8 EUR / PC

Illumigraph, washable ink
RAX 020-58 7.05 EUR / PC
Posterman, water resistant ink
RAX 026-58 6.89 EUR / PC

Labelling wire, pistol for wire application



Standard pistols for labelling wires application. To be used for normal textile labelling jobs.

UPP 010-31/ST 22.2 EUR / PC



Heavy-duty pistol for labelling wires application. To be used for thick fabrics, carpets or other tough materials.

UPP 010-31/HD 44.95 EUR / PC



Spare pin for standard pistol. Total length 33 mm, working length 10 mm, thickness 2.03 mm. Delivered in sets of 5.

UPP 011-31/ST 8.8 EUR / SET



Spare pin for heavy-duty pistol. Total length 43 mm, working length 20 mm, thickness 2.29 mm.

UPP 011-31/HD 13.05 EUR / PC



Standard labelling wires, polypropylene, various lengths. Available colors: natural. Minimum delivery: 5000 pcs.

Working length 20 mm
UPP 050-31/20PP 2.1 EUR / 1000PCS

Working length 40 mm
UPP 050-31/40PP 2.4 EUR / 1000PCS

Working length 65 mm
UPP 050-31/65PP 2.7 EUR / 1000PCS

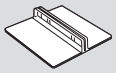

Plexiglass, polystyrene, PVC, polypropylene, PET: these are raw materials used in our every day production. We keep them in stock in considerable quantities and we process them into pockets, menu holders, label holders, foils, displays, exactly as per our client's requirements. We screen and digitally print them, we bend them, stitch, glue, punch, mill and deliver them always in time.

You are welcome to see how your project is coming into reality from a simple piece of plastic.

